



全漢企業股份有限公司

SPI Electronic Co., Ltd.

台灣桃園市建國東路 22 號  
TEL : 886-3-375-9888  
<http://www.fsp-group.com.tw>

No. 22, Jianguo E. Rd., Taoyuan City,  
Taiwan, R.O.C.  
FAX : 886-3-375-6966  
Email:sales@mail.fsp-group.com.tw

# MECHANICAL DRAWING



OAD06038040

FSP250-50GUB

Released Date:2006/12/19-16:2:31

REF. ID.	PIN NO.	SIGNAL	WIRE COLOR	GUAGE	CONNECTOR TYPE	CABLE LENGTH
P1	1	+3.3VDC	ORANGE	20	MOLEX CL1270H00 15P or EQUIV.	200 + <sup>20</sup> mm
	2	+3.3VDC	ORANGE	20		
	3	COM	BLACK	20		
	4	+5VDC	RED	20		
	5	COM	BLACK	20		
	6	+5VDC	RED	20		
	7	COM	BLACK	20		
	8	PW-ON	GRAY	24		
	9	+5VSB	PURPLE	22		
	10	+12V	YELLOW	20		
	11	+12V	YELLOW	20		
	12	+3.3VDC	ORANGE	20		
	13	+3.3VDC	ORANGE	24		
	14	+3.3VDC	BROWN	24		
	15	-12VDC	BLUE	24		
	16	COM	BLACK	24		
	17	PS-ON	GREEN	24		
	18	COM	BLACK	20		
	19	COM	BLACK	20		
20	COM	BLACK	20			
21	+5VDC	RED	20	MOLEX	300 + <sup>20</sup> mm	
22	+5VDC	RED	20			
23	+5VDC	RED	20			
24	COM	BLACK	20			
P2	1	+3.3V	ORANGE	20	MOLEX CL1270H00 15P or EQUIV.	300 + <sup>20</sup> mm
	2	COM	BLACK	20		
	3	+5V	RED	20		
	4	COM	BLACK	20		
P3	1	+12V	YELLOW	20	MOLEX 39-01-3040 250 + <sup>20</sup> mm or EQUIV.	300 + <sup>20</sup> mm
	2	COM	BLACK	20		
	3	+12V	YELLOW	20		
	4	+12V	YELLOW	20		
P4	1	+12V	YELLOW	20	MOLEX 1-480424-0 300 + <sup>20</sup> mm or EQUIV.	300 + <sup>20</sup> mm
	2	COM	BLACK	20		
	3	COM	BLACK	20		
	4	+5V	RED	20		
P5	1	+5V	RED	22	MOLEX 171822-4 150±10mm or EQUIV.	150±10mm
	2	COM	BLACK	22		
	3	COM	BLACK	22		
	4	+12V	YELLOW	22		
P6	1	+12V	YELLOW	20	MOLEX 1-480424-0 300 + <sup>20</sup> mm or EQUIV.	300 + <sup>20</sup> mm
	2	COM	BLACK	20		
	3	COM	BLACK	20		
	4	+5V	RED	20		
P7	1	+12V	YELLOW	22	MOLEX 1-480424-0 150±10mm or EQUIV.	150±10mm
	2	COM	BLACK	22		
	3	COM	BLACK	22		
	4	+5V	RED	22		

NOTE:  
1. ALL THE LENGTH OF OUTPUT WIRES EXCLUDE HOUSING.  
2. 產地標識依業務指示加貼。

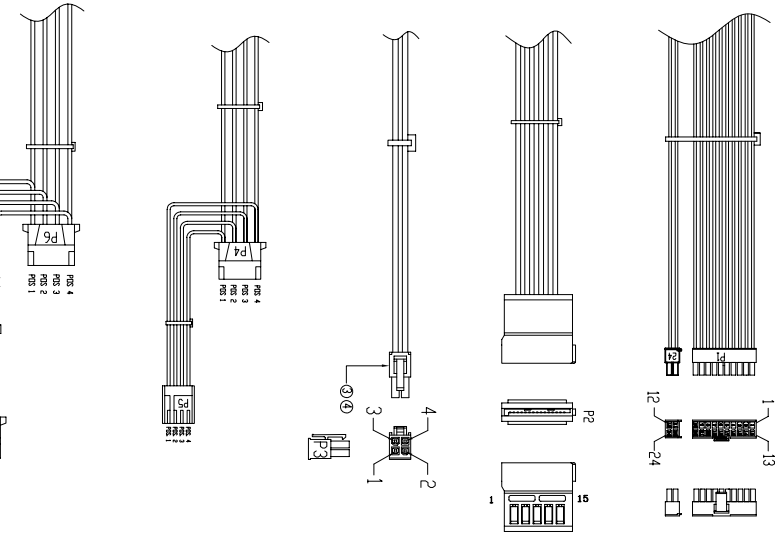
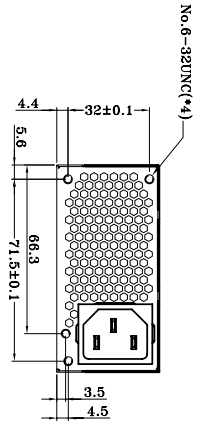
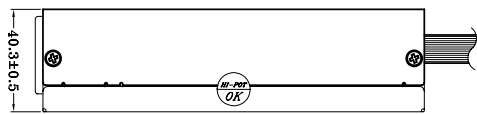
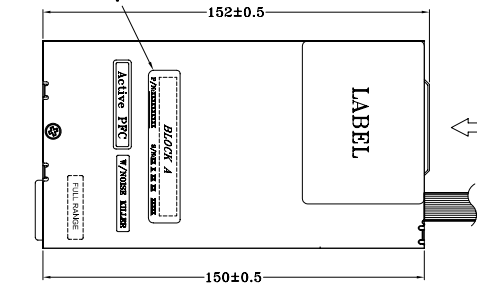
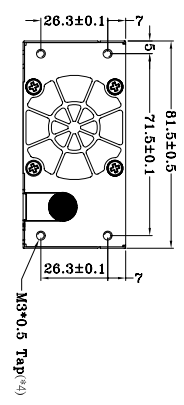
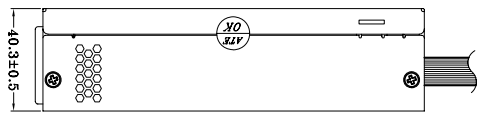
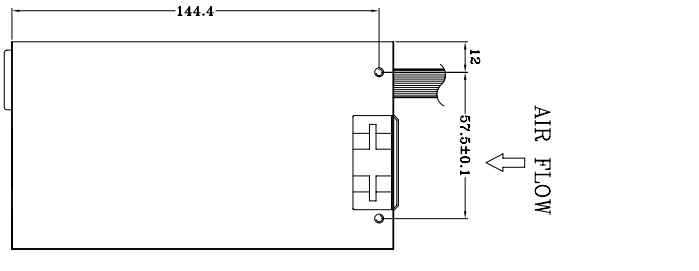

UNIT:mm

P/N:9PA250BG00

MODEL NO. : RSP250-50GUB	TITLE: ASSY	SHEET: 1 OF 1	REV:08
R&D(8)	PE	CHECKED	DESIGN
INTERIOR COUNTERSIGN:			
			DATE DEC.15.2006
			賴俊佑